

Samstag, 24. Juni 2017

- 08:30 Paid Warm up Trail (5 Minuten pro Nennung) / Entries: 10
- 10:00 173000 Performance Halter Stallions / Entries: 1
273000 Amt Performance Halter Stallions / Entries: 1
- 10:15 107200 Geldings Three and Over / Entries: 2
207202 L1 Amt Geldings Three & Over / Entries: 6
207200 Amt Geldings Three & Over / Entries: 3
407200 Youth Geldings Three & Over / Entries: 3
- 10:45 105600 Three Yr Old Mares / Entries: 3
105700 Aged Mares / Entries: 6
205202 L1 Amt Mares Three & Over / Entries: 3
205200 Amt Mares Three & Over / Entries: 5
405200 Youth Mares Three & Over / Entries: 2
- 11:30 DY120 RO-Jugend Showmanship At Halter / Entries: 1
- 11:30 DN120 RO-Einsteiger Showmanship At Halter / Entries: 3
212002 L1 Amt Showmanship at Halter / Entries: 8
212000 Amt Showmanship at Halter / Entries: 5
- 12:00 412002 L1 Youth Showmanship at Halter / Entries: 4
- 12:00 412000 Youth Showmanship at Halter / Entries: 4
- 12:45 S008 Trail In Hand / Entries: 5
- 13:00 138004 L1 Trail / Entries: 14
- 13:45 438002 L1 Youth Trail / Entries: 5
438000 Youth Trail / Entries: 4
- 14:30 138000 Trail / Entries: 11
- 15:45 DN340 RO-Einsteiger Reining / Entries: 1
234002 L1 Amt Reining / Entries: 1
234000 Amt Reining / Entries: 1
- 16:15 DN430 RO-Einsteiger Ranch Riding / Entries: 1
243002 L1 Amt Ranch Riding / Entries: 2
- 16:30 243000 Amt Ranch Riding / Entries: 1
- 16:40 142004 L1 Western Pleasure / Entries: 7
anschl. 442002 L1 Youth Western Pleasure / Entries: 4
anschl. 442000 Youth Western Pleasure / Entries: 3
anschl. 440002 L1 Youth Western Horsemanship / Entries: 4
anschl. 440000 Youth Western Horsemanship / Entries: 5
anschl. 142000 Western Pleasure / Entries: 5

Der Veranstalter behält sich vor, die Prüfungen bis zu 30 Minuten vor den genannten Zeiten zu beginnen. Jeder Teilnehmer ist für das rechtzeitige Erscheinen zur genannten Klasse selbst verantwortlich. Bitte auf die Ansagen achten.

Sonntag, 25. Juni 2017

- 8:00 144004 L1 Hunter Under Saddle / Entries: 7
 444002 L1 Youth Hunter Under Saddle / Entries: 4
 444000 Youth Hunter Under Saddle / Entries: 3
 244002 L1 Amt Hunter Under Saddle / Entries: 4
 244000 Amt Hunter Under Saddle / Entries: 4
 144000 Hunter Under Saddle / Entries: 4
- 9:30 452002 L1 Youth Hunt Seat Equitation / Entries: 3
 452000 Youth Hunt Seat Equitation / Entries: 1
 252002 L1 Amt Hunt Seat Equitation / Entries: 3
 252000 Amt Hunt Seat Equitation / Entries: 3
- 10:15 136004 L1 Western Riding / Entries: 4
 236002 L1 Amt Western Riding / Entries: 1
 236000 Amt Western Riding / Entries: 1
 136000 Western Riding / Entries: 4
- 11:30 DY381 RO-Jugend Walk Trot Trail / Entries: 4
 11:30 DN381 RO-Einsteiger Walk-Trot-Trail / Entries: 2
 11:45 DY380 RO-Jugend Trail / Entries: 1
 11:45 DN380 RO-Einsteiger Trail / Entries: 7
- 12:15 238002 L1 Amt Trail / Entries: 4
 12:30 238000 Amt Trail / Entries: 4
- 13:00 S043 Kinder Ranch Riding (lead) / Entries: 1
 13:15 143004 L1 Ranch Riding / Entries: 3
 443002 L1 Youth Ranch Riding / Entries: 1
 13:30 143000 Ranch Riding / Entries: 2
- 14:00 434002 L1 Youth Reining / Entries: 2
 434000 Youth Reining / Entries: 1
- 14:20 134004 L1 Reining / Entries: 2
 14:30 134000 Reining / Entries: 1
- 14:55 DY421 RO-Jugend Walk Trot Pleasure / Entries: 4
 14:55 DN421 RO-Einsteiger Walk Trot Pleasure / Entries: 2
- 15:15 DN420 RO-Einsteiger Western Pleasure / Entries: 3
 15:30 242002 L1 Amt Western Pleasure / Entries: 2
 15:45 242000 Amt Western Pleasure / Entries: 4
- 16:00 DY401 RO-Jugend Walk Trot Horsemanship / Entries: 4
 16:00 DN401 RO-Einsteiger Walk Trot Horsemanship / Entries: 2
 anschl. DN400 RO-Einsteiger Western Horsemanship / Entries: 3
 anschl. 240002 L1 Amt Western Horsemanship / Entries: 3
 anschl. 240000 Amt Western Horsemanship / Entries: 3

1	Aint Dun Trippin	Monn; Manuela	31	CL Invest Impulsion	Winkler; Melanie
2	BPR Pretty Bailey	Schmid; Rebecca			Dorsch; Elena
3	Caramel	Wilczinski; Dieter	32	Extremely Fancy NRed	Gallitzendoerfer; Angelika
4	Ima Zippo Star	Spaeth; Karsten	33	The King Of Texas	Fleek; Diana
5	Rocky B Rollin	Spaeth; Lara	34	Lancers Little Jack	Riedele; Thomas
6	Gun Socks Choice	Berger; Johanna	35	My Blue Sunshine	Woitaschek; Silke
7	Heza Movin Star	Heinle; Larissa	36	Little Golden Pepper	Holzaepfel; Bianca
8	Rods Hot Chocolate	Buehlmaier; Christin	37	Stitch	Eberhardt; Lea Marie
9	Be Coeur D Broady	Risse; Franziska	38	The Green Version	Kirmaier; Amrei Sophia
10	Reminics Jac	Eberhardt; Lea Marie	39	Spook N Smoke	Stauss; Marlene
11	Anotherenterprisgun	Eberhardt; Alexander			Stauss; Lina
12	MJ A Good Remedy	Dorfmeister; Franziska	40	Solano San Sue	Wuerth; Alexandra
13	HC Wisely On Top	Dorfmeister; Franziska			Fischer; Brigitte
14	RC Helen San Badger	Groene; Michaela			Majer; Lina
15	Hot Mojito	Schmid; Sarah	41	Nites Lark Chocolate	Holderer-Rieger; Andrea
16	Ivy Blues	Schmid; Sarah	42	Aint It The Blues	Meier-Bidmon; Gesa
17	Higgins Lill Hillary	Hendrichske; Nicole	43	Little Blue Birdy	Meier-Bidmon; Gesa
18	Lady Radical	Heinzmann; Eva	44	ILikeToDanze	Meier-Bidmon; Gesa
19	Good Time Blues	Celine; Buss	45	Blue Socks Only	Stauss; Marlene
20	Doc Kitty Doll	Celine; Buss	46	YouThinkYouKnowMe	Linder; Lisa-Maria
		Buss; Michaela			
21	LQSpecialChiliPepper	Linsenmaier; Sara			
		Schmid; Sarah			
22	Krymsunizer	Lebermann; Maike			
23	CM Hollywood Gold	Friz; Maren			
24	Showlution	Haederle; Alexandra			
25	Marry Me Wisely	Hinderer; Anna			
26	Paulena Night Slide	Hinderer; Maja			
27	RS Hermes Olena	Goeggel; Anna			
28	Annie Award	Dietzel; Silvia			
29	Shes Lopin Lazy	Dietzel; Silvia			
30	Makin My Own Way	Reicherter; Sabrina			

Starterlisten

In allen Klassen werden die Startreihenfolgen ausgelost!

Die aktuellen Starterlisten für die jeweiligen Klassen werden von der Meldestelle ausgehängt. Bitte beachten Sie auch die Lautsprecherdurchsagen. In dem Programmheft sind nur die bis Nennschluss eingegangenen Nennungen aufgeführt.

Jeder Teilnehmer ist für das rechtzeitige Erscheinen selbst verantwortlich.

AQHA Albuch Open 2017

Patterns aus dem Regelbuch

unter: <http://www.dqha.de/dqha/regelwerke/>

Prüfungsnummer Division

Pattern

Reining

134000	Open	9
134004	L1 Open (Green)	8
234000	Amateur	8
234002	L1 Amateur (Novice Amateur)	5
434000	Youth	6
434002	L1 Youth (Novice Youth)	6
DN/DY340	Rasseoffen	5



Western Riding

136000	Open	1
136004	L1 Open (Green)	L1/Green 1
236000	Amateur	1
236002	L1 Amateur (Novice Amateur)	L1/Green 1
436000	Youth	4
436002	L1 Youth (Novice Youth)	L1/Green 3
DN/DY360	Rasseoffen	5

Ranch Riding

143000	Open	4
143004	L1 Open (Green)	1
243000	Amateur	1
243002	L1 Amateur (Novice Amateur)	2
443000	Youth	6
443002	L1 Youth (Novice Youth)	6
DN/DY430	Rasseoffen	2



Showmanship at Halter

Novice Youth/Youth, Novice Amateur + Rasseoffen

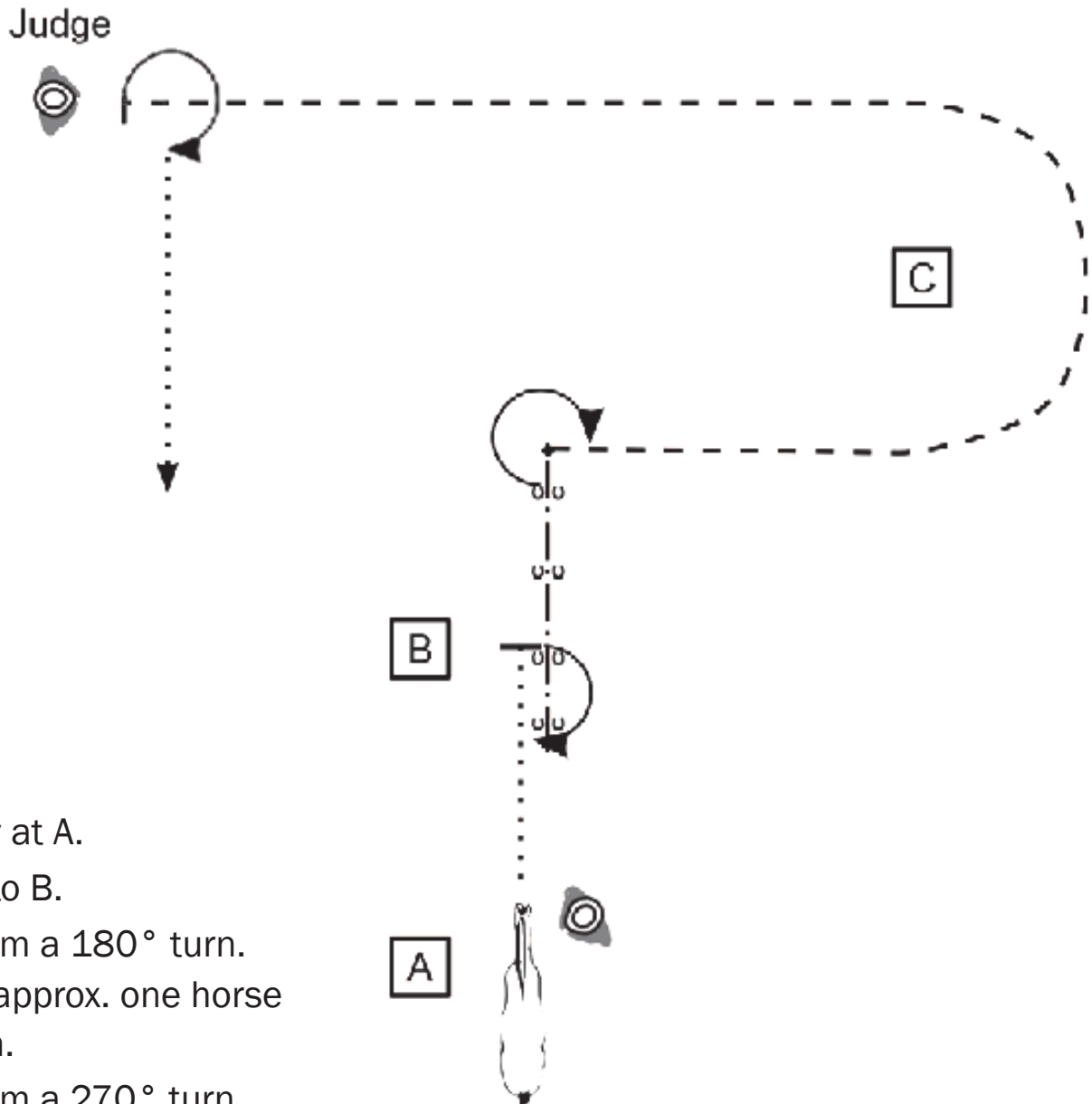

Be ready at A.

1. Walk to B.
2. Perform a 180° turn.
3. Back approx. one horse length.
4. Perform a 270° turn.
5. Trot around C and to judge.
6. Stop and set up for inspection.
7. When dismissed, perform a 270° turn.
8. Walk straight away from judge.

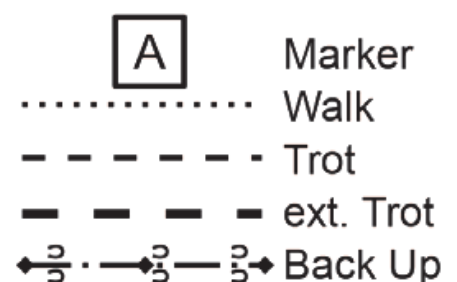

Showmanship at Halter
Amateur

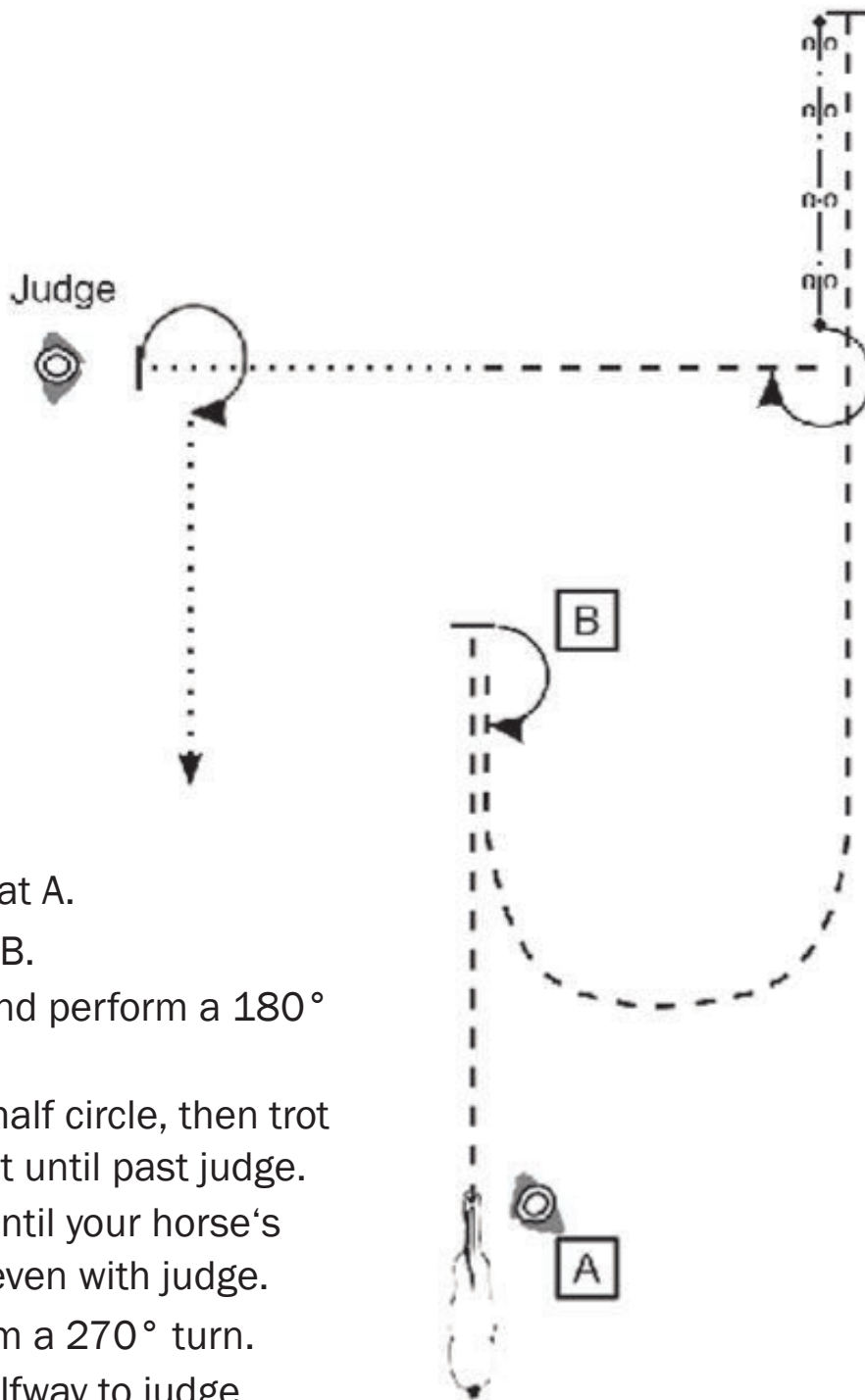

Be ready at A.

1. Trot to B.
2. Stop and perform a 180° turn.
3. Trot a half circle, then trot straight until past judge.
4. Back until your horse's hip is even with judge.
5. Perform a 270° turn.
6. Trot halfway to judge, then walk to judge. Stop and set up for inspection.
7. When dismissed, perform a 270° turn and walk away.

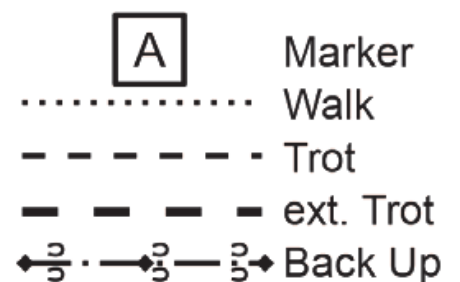

Western Horsemanship

Novice Youth/Youth, Novice Amateur + Rasseoffen

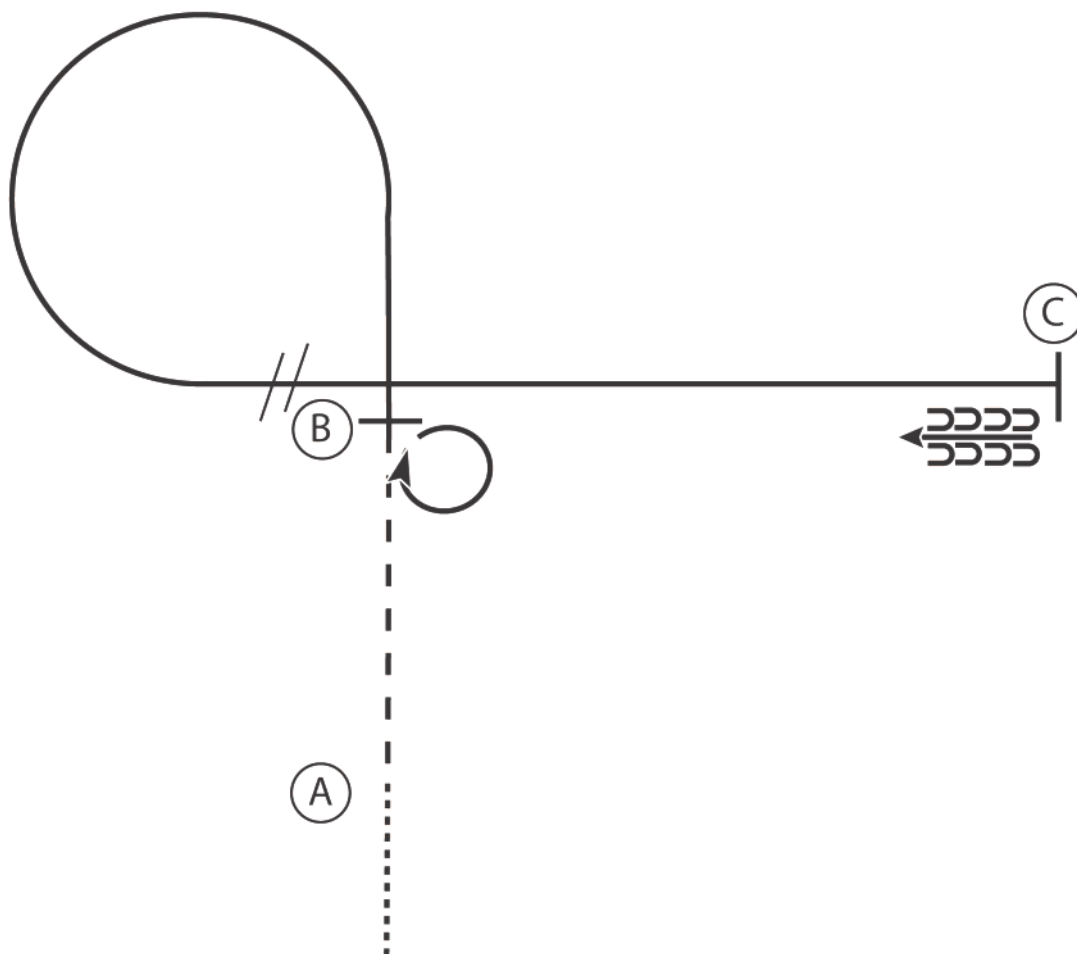

1. Walk to A
2. At A jog to B
3. Stop at B and perform a 360 degree turn to the right
4. Lope a circle to the left
5. At B perform a lead change and continue to C
6. At C stop and back 5 steps

Walk
Jog	-----
Extended Jog	— — — —
Lope	—————
Leg Yield	
Lead Change	↘
Back	←←←←← ←←←←←
Marker	(B)
Sidepass	←- - - - - ←

Western Horsemanship
Amateurs

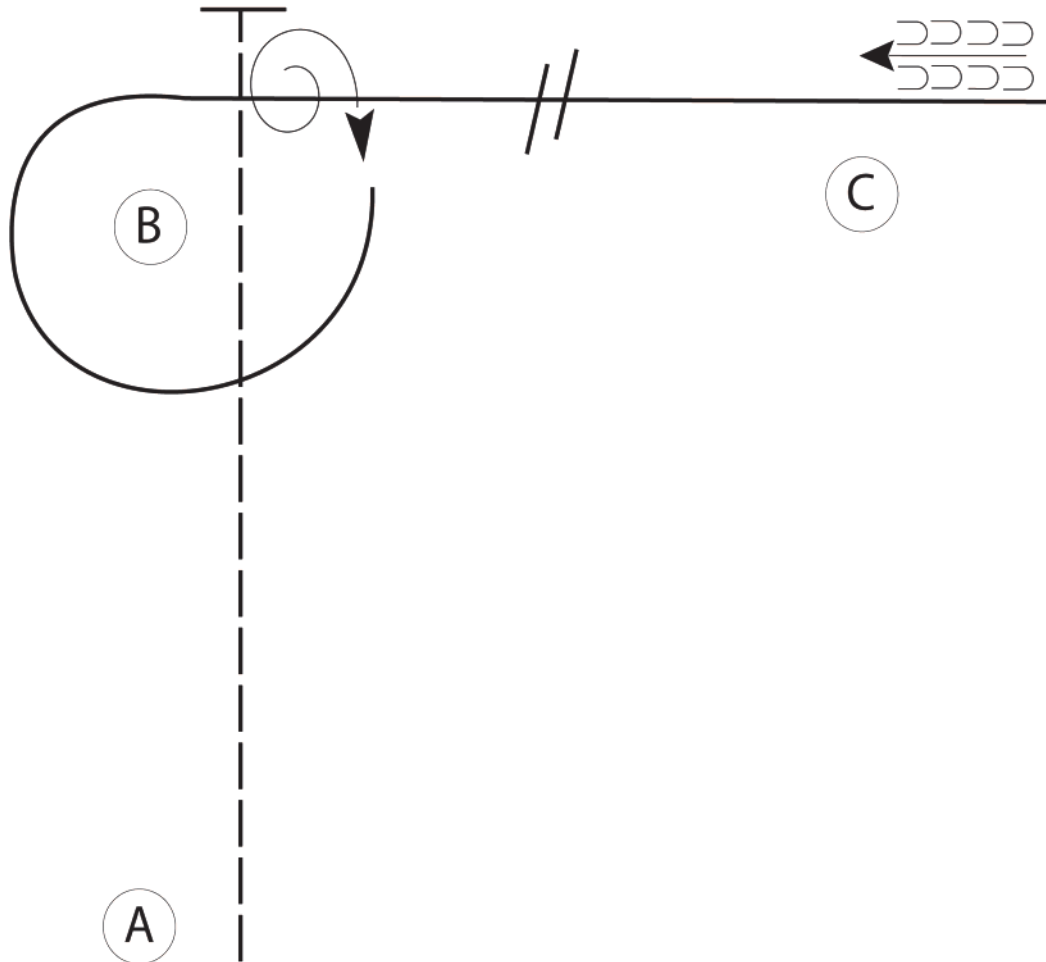

Be ready at A.

1. Perform an extended jog from A past B
 2. Stop past B and perform a 540 degree turn to the right.
 3. Lope on the right lead around B and continue towards C.
 4. Half way between B and C perform a simple lead change.
 5. Continue to lope past C and stop.
 6. Back to C.
- Follow the instructions of your ring steward.

Walk	-----
Jog	-----
Extended Jog	-----
Lope	—————
Leg Yield	
Lead Change	— / —
Back	← D D D D D D D D
Marker	⊙ B
Sidepass	← - - - - - →

Western Horsemanship

Walk-Trot Rasseoffen

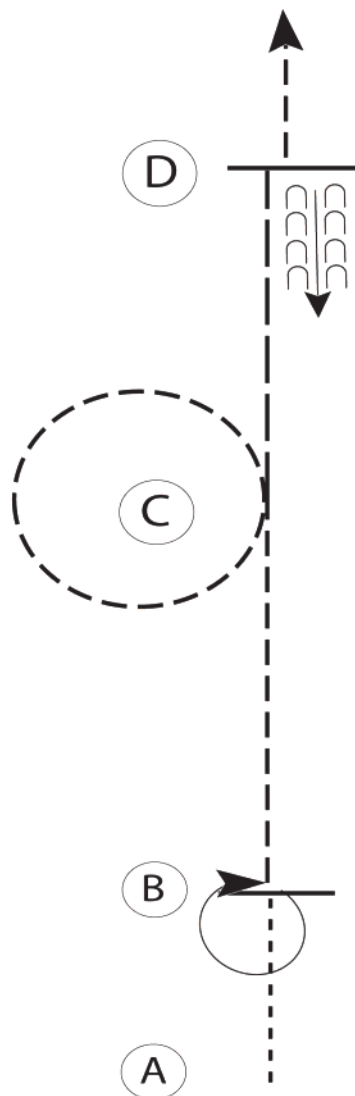

1. Walk from A to B
2. At B stop and perform a 360 degree turn on the hindquarters to the right
3. Jog to C, and jog a circle around C to the left
4. Extend the jog to D
5. At D stop, back five steps, and jog to the line

Walk	-----
Jog	-----
Extended Jog	-----
Lope	-----
Leg Yield	
Lead Change	↘
Back	←
Marker	(B)
Sidepass	←-----→



Hunt Seat Equitation

L1 Novice Youth, L1 Novice Amateur

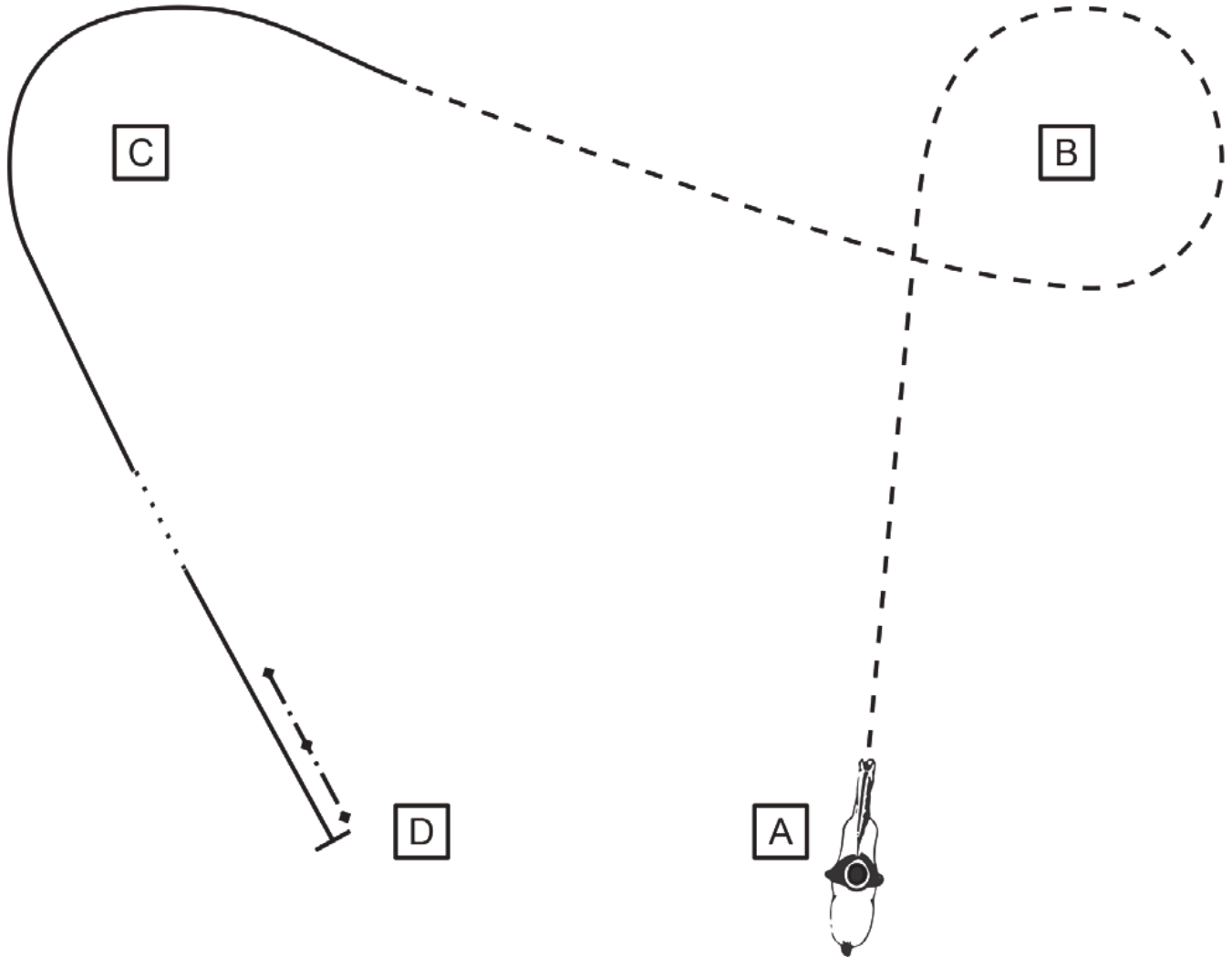

Be ready at A.

1. Trot on left diagonal around B.
2. Change diagonals at mid-point to C.
3. Canter on left lead around C.
4. At mid-point to D, walk 2 strides.
5. Depart on right lead to D.
6. Stop and back two horse length.

A	Marker
.....	Walk
-----	Trot
- - - - -	ext. Trot
—————	Canter
—————	Hd Gallop
◄- - - - -►	Backup
no→	Sidepass
————— X	Lead Change

Hunt Seat Equitation

Youth, Amateur

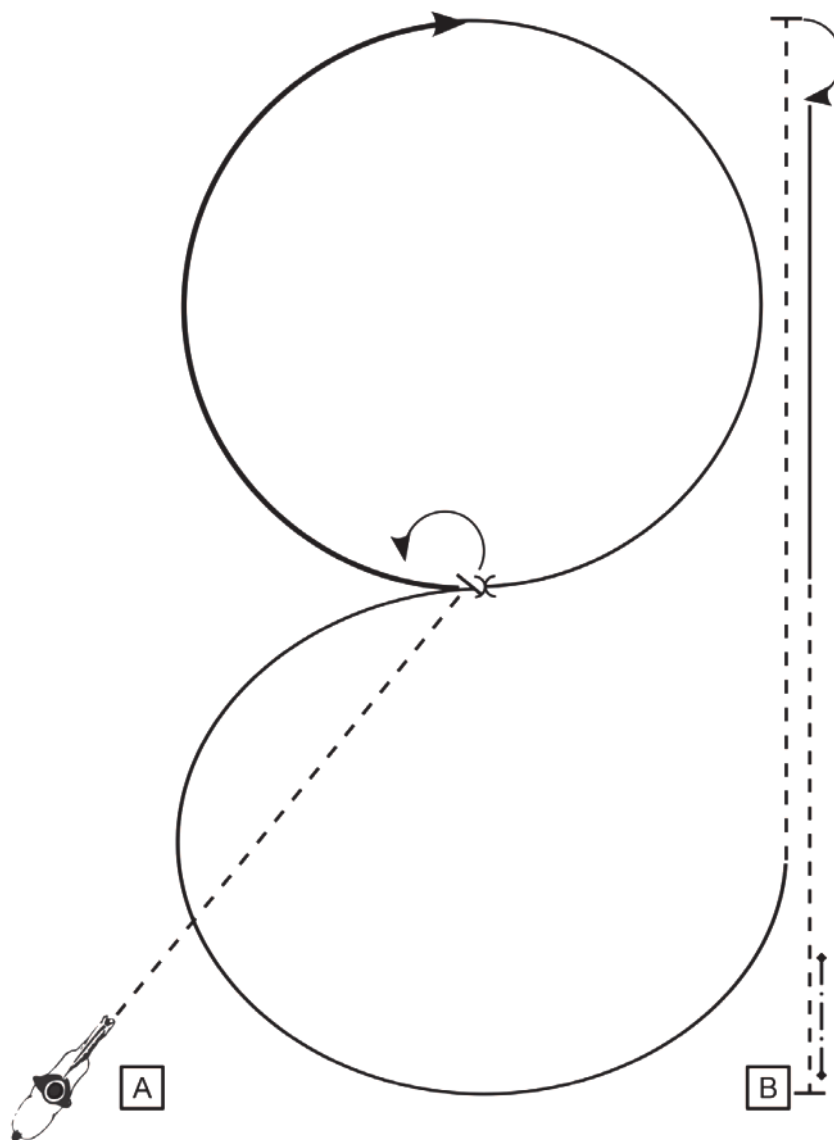

1. Sitting trot half way and posting trot left diagonal to stop.
2. Execute a 135° turn on the forehand to the left.
3. Hand gallop right lead half a circle.
4. Canter and change lead at center.
5. Canter 3/4 circle left lead, posting trot right diagonal.
6. Stop, execute a 180° turn on the forehand to the right.
7. Canter left lead, half way sitting trot.
8. Stop, back one horse length.

A	Marker
.....	Walk
- - - - -	Trot
- - - - -	ext. Trot
—————	Canter
—————	Hd Gallop
◄ - - - - - ►	Backup
no>	Sidepass
————— X	Lead Change

Ranch Riding Kinder (lead line) (bis 14 Jahre)

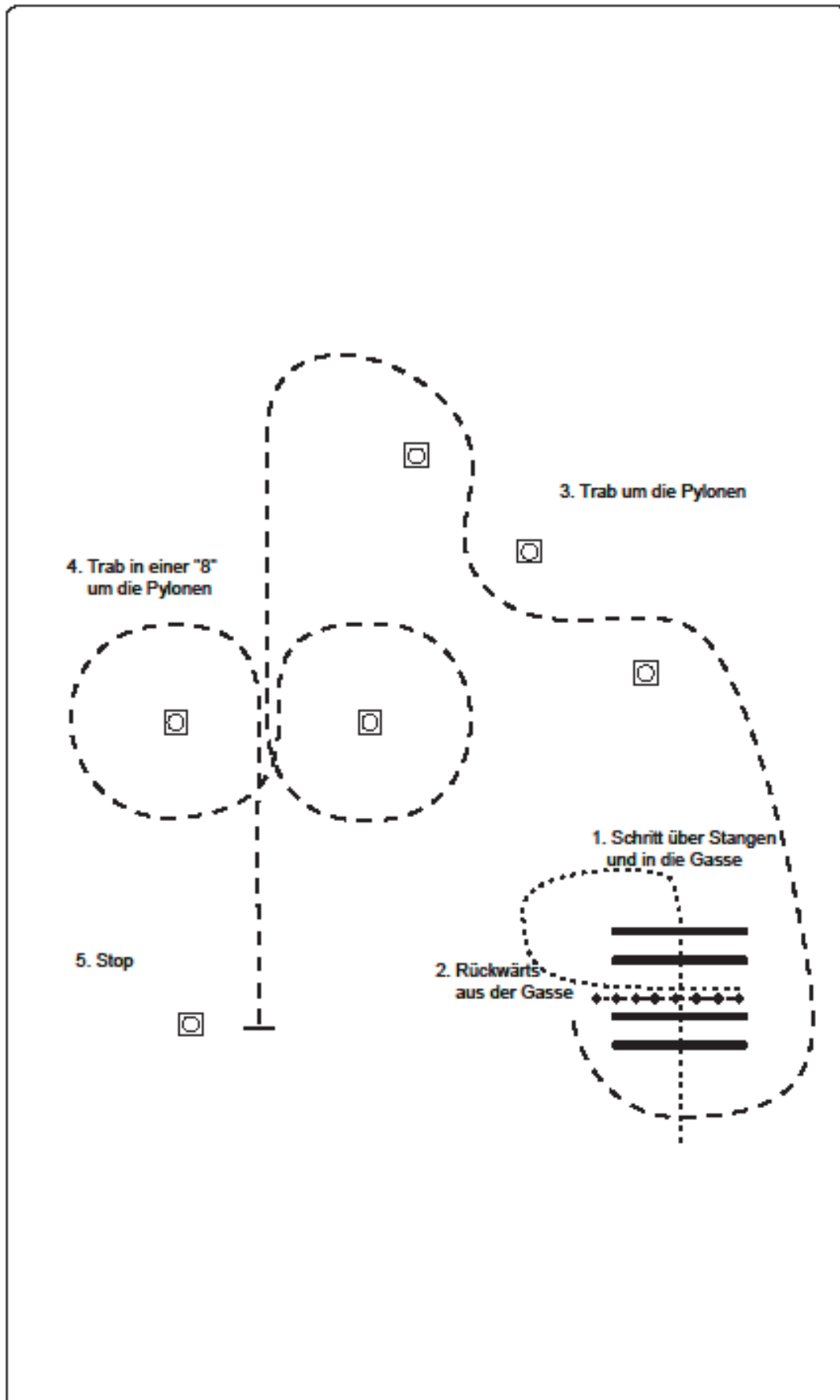

Trail

Walk Trot Rasseoffen, Trail in Hand



2017 DQHA TRAIL COURSE

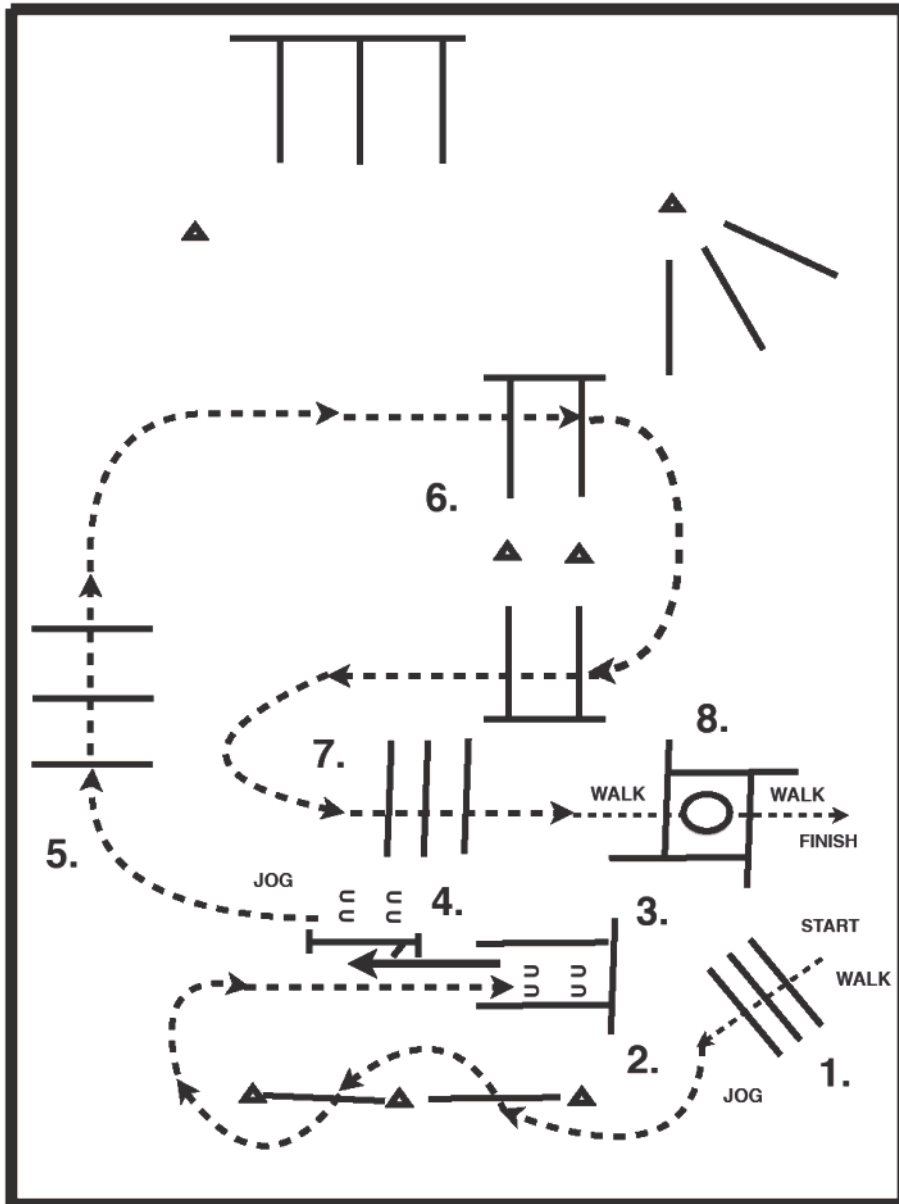

1. WALK OVER POLES.
2. JOG THRU SERPENTINE, JOG OVER POLES, JOG INTO CHUTE.
3. BACK THRU POLES, BACK TO GATE.
4. GATE: LEFT HAND OPEN WALK THRU GATE, AND CLOSE GATE.
5. JOG OVER POLES.
6. JOG OVER POLES
7. JOG OVER POLES, STOP OR BREAK TO WALK, THEN WALK INTO BOX EXECUTE A 360 TURN EITHER WAY WALK OUT BOX
8. STOP OR BREAK TO WALK, THEN WALK INTO BOX EXECUTE A 360 TURN EITHER WAY WALK OUT BOX

TRAIL COURSES DESIGNED BY
TIM KIMURA/DQHA COPYRIGHT 2017
ALL RIGHTS RESERVED.



Trail Green, L1, rasseoffen

L1 Green, L1 N. Youth, L1 N. Amateur, Rasseoffen



2017 DQHA TRAIL COURSE

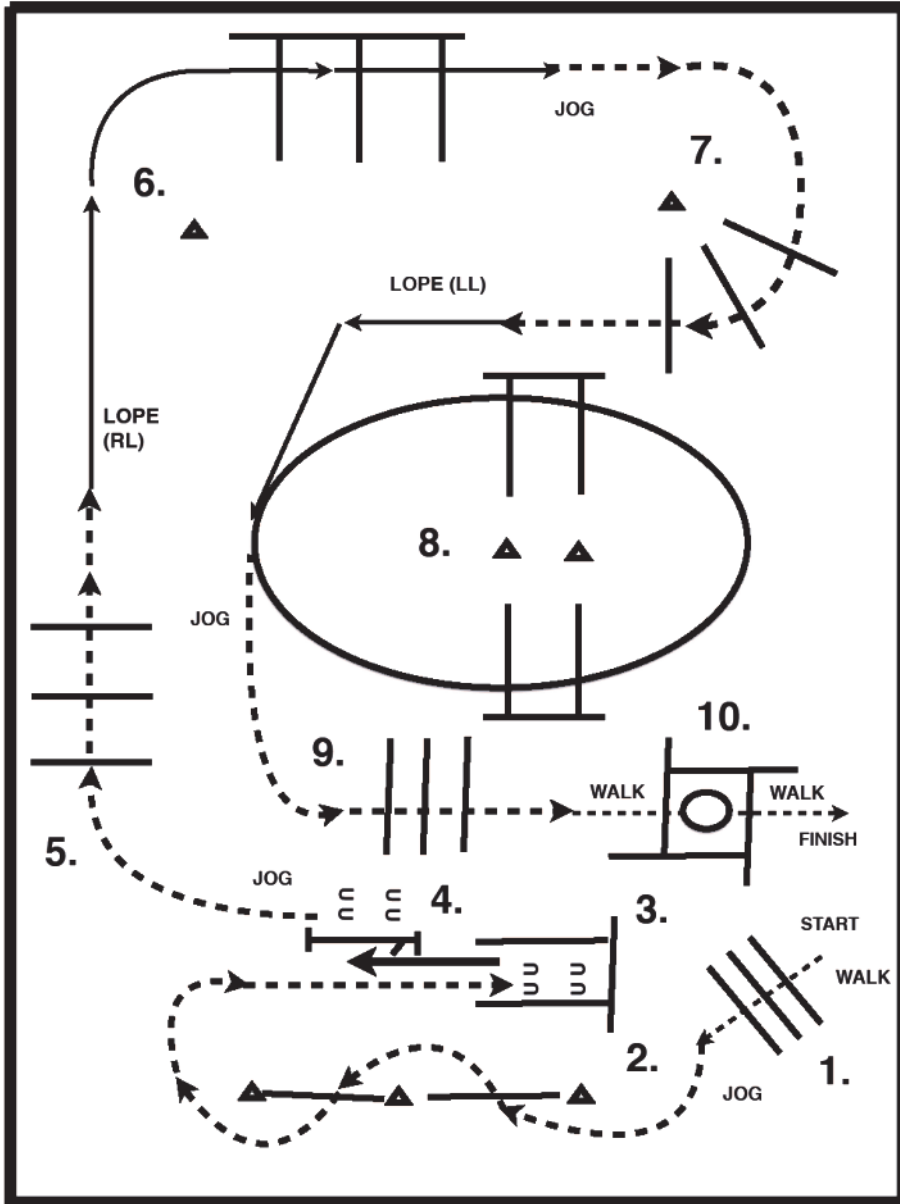

1. WALK OVER POLES.
2. JOG THRU SERPENTINE, JOG OVER POLES, JOG INTO CHUTE.
3. BACK THRU POLES, BACK TO GATE.
4. GATE: LEFT HAND OPEN AND WALK THRU AND CLOSE GATE.
5. JOG OVER POLES.
6. LOPE OVER POLES (RIGHT LEAD).
7. BREAK TO JOG JOG OVER POLES.
8. LOPE OVER POLES (LEFT LEAD)
9. BREAK TO JOG, JOG OVER POLES,
10. STOP OR BREAK TO WALK, THEN WALK INTO BOX EXECUTE A 360 TURN EITHER WAY WALK OUT BOX

TRAIL COURSES DESIGNED BY
TIM KIMURA/DQHA COPYRIGHT 2017
ALL RIGHTS RESERVED.



Trail Youth, Amateur



2017 DQHA TRAIL COURSE

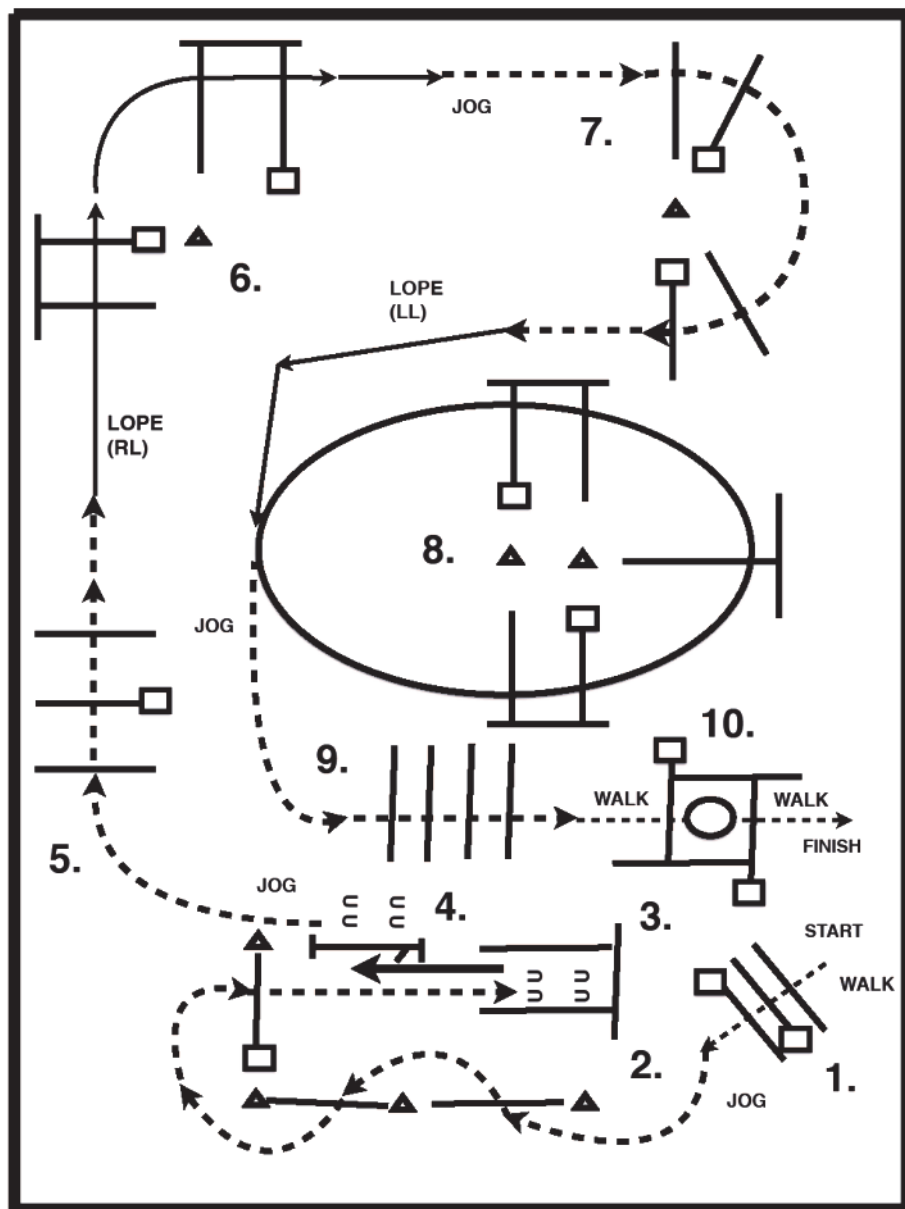

1. WALK OVER POLES.
2. JOG THRU SERPENTINE, JOG OVER POLES, JOG INTO CHUTE.
3. BACK THRU POLES, BACK TO GATE.
4. GATE: LEFT HAND OPEN WALK OVER POLE, CLOSE GATE.
5. JOG OVER POLES.
6. LOPE OVER POLES (RIGHT LEAD).
7. BREAK TO JOG JOG OVER POLES.
8. LOPE OVER POLES (LEFT LEAD)
9. BREAK TO JOG, JOG OVER POLES,
10. STOP OR BREAK TO WALK, THEN WALK INTO BOX EXECUTE A 360 TURN EITHER WAY WALK OUT BOX

TRAIL COURSES DESIGNED BY
 TIM KIMURA/DQHA COPYRIGHT 2017
 ALL RIGHTS RESERVED.

□
 BLOCKS
 ARE OPTIONAL



**Trail
Open**



2017 DQHA TRAIL COURSE

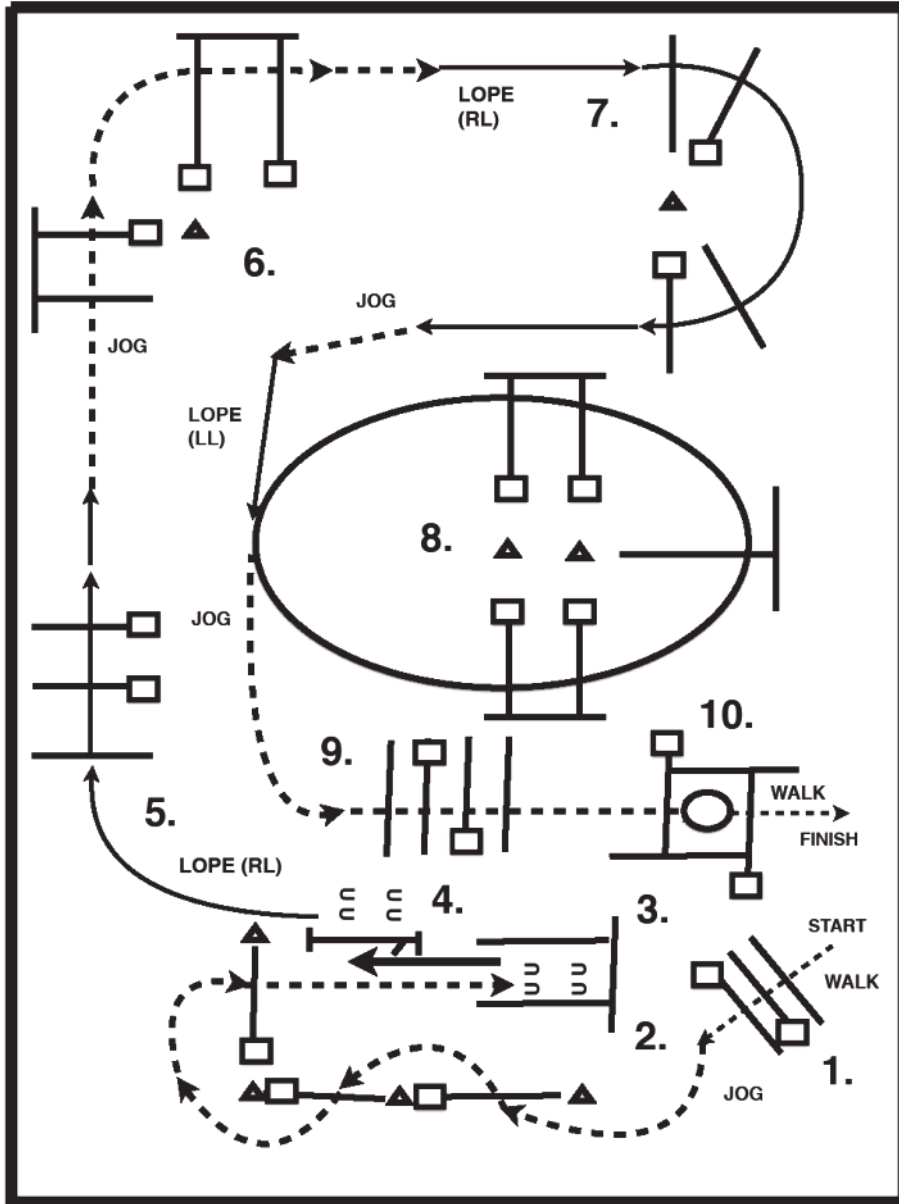

1. WALK OVER POLES.
2. JOG THRU SERPENTINE, JOG OVER POLES, JOG INTO CHUTE.
3. BACK THRU POLES, BACK TO GATE.
4. GATE: LEFT HAND OPEN WALK OVER POLE, CLOSE GATE.
- 5 LOPE OVER POLES (RIGHT LEAD)
6. BREAK TO JOG, JOG OVER POLES..
7. LOPE OVER POLES (RIGHT LEAD)
8. BREAK TO A JOG, THEN LOPE OVER POLES (LEFT LEAD).
9. BREAK TO JOG, JOG OVER POLES,
10. JOG INTO BOX, STOP THEN EXECUTE A 360 TURN EITHER WAY WALK OUT BOX

TRAIL COURSES DESIGNED BY
TIM KIMURA/GQHA COPYRIGHT 2017
ALL RIGHTS RESERVED.

